



SERVICE MANUAL

MODEL TYPE: ES700P
LS700P

WEB ACCESS: <http://www.yorkville.com>

WORLD HEADQUARTERS CANADA

Yorkville Sound
550 Granite Court
Pickering, Ontario
L1W-3Y8 CANADA

Voice: (905) 837-8481
Fax: (905) 837-8746

U.S.A.

Yorkville Sound Inc.
4625 Witmer Industrial Estate
Niagara Falls, New York
14305 USA

Voice: (716) 297-2920
Fax: (716) 297-3689



Quality and Innovation Since 1963
Printed in Canada

IMPORTANT SAFETY INSTRUCTIONS



INSTRUCTIONS PERTAINING TO A RISK OF FIRE, ELECTRIC SHOCK, OR INJURY TO PERSONS

CAUTION:

TO REDUCE THE RISK OF ELECTRIC SHOCK, DO NOT REMOVE COVER (OR BACK).

NO USER SERVICEABLE PARTS INSIDE.

REFER SERVICING TO QUALIFIED SERVICE PERSONNEL.

INSTRUCTIONS RELATIVES AU RISQUE DE FEU, CHOC ÉLECTRIQUE, OU BLESSURES AUX PERSONNES

AVIS:

AFIN DE REDUIRE LES RISQUE DE CHOC ELECTRIQUE, N'ENLEVEZ PAS LE COUVERT (OU LE PANNEAU ARRIERE)

NE CONTIENT AUCUNE PIECE REPARABLE PAR L'UTILISATEUR.

CONSULTEZ UN TECHNICIEN QUALIFIE POUR L'ENTRETIEN

Read Instructions

The Owner's Manual should be read and understood before operation of your unit. Please, save these instructions for future reference.

Packaging

Keep the box and packaging materials, in case the unit needs to be returned for service.

Warning

When using electric products, basic precautions should always be followed, including the following:

Power Sources

Your unit should be connected to a power source only of the voltage specified in the owners manual or as marked on the unit. This unit has a polarized plug. Do not use with an extension cord or receptacle unless the plug can be fully inserted. Precautions should be taken so that the grounding scheme on the unit is not defeated.

Hazards

Do not place this product on an unstable cart, stand, tripod, bracket or table. The product may fall, causing serious personal injury and serious damage to the product. Use only with cart, stand, tripod, bracket, or table recommended by the manufacturer or sold with the product. Follow the manufacturer's instructions when installing the product and use mounting accessories recommended by the manufacturer.

The apparatus should not be exposed to dripping or splashing water; no objects filled with liquids should be placed on the apparatus.

Terminals marked with the "lightning bolt" are hazardous live; the external wiring connected to these terminals require installation by an instructed person or the use of ready made leads or cords.

No naked flame sources, such as lighted candles, should be placed on the apparatus.

Power Cord

The AC supply cord should be routed so that it is unlikely that it will be damaged. If the AC supply cord is damaged DO NOT OPERATE THE UNIT.

Service

The unit should be serviced only by qualified service personnel.

Veillez Lire le Manuel

Il contient des informations qui devraient être comprises avant l'opération de votre appareil. Conservez S.V.P. ces instructions pour consultations ultérieures.

Emballage

Conservez la boîte au cas où l'appareil devait être retourner pour réparation.

Attention:

Lors de l'utilisation de produits électrique, assurez-vous d'adhérer à des précautions de bases incluant celle qui suivent:

Alimentation

L'appareil ne doit être branché qu'à une source d'alimentation correspondant au voltage spécifié dans le manuel ou tel qu'indiqué sur l'appareil. Cet appareil est équipé d'une prise d'alimentation polarisée. Ne pas utiliser cet appareil avec un cordon de raccordement à moins qu'il soit possible d'insérer complètement les trois lames. Des précautions doivent être prises afin d'éviter que le système de mise à la terre de l'appareil ne soit désengagé.

Risque

Ne pas placer cet appareil sur un chariot, un support, un trépied ou une table instables. L'appareil pourrait tomber et blesser quelqu'un ou subir des dommages importants. Utiliser seulement un chariot, un support, un trépied ou une table recommandés par le fabricant ou vendus avec le produit. Suivre les instructions du fabricant pour installer l'appareil et utiliser les accessoires recommandés par le fabricant.

Il convient de ne pas placer sur l'appareil de sources de flammes nues, telles que des bougies allumées.

L'appareil ne doit pas être exposé à des égouttements d'eau ou des éclaboussures et qu'aucun objet rempli de liquide tel que des vases ne doit être placé sur l'appareil.

Les dispositifs marqués d'une symbole "d'éclair" sont des parties dangereuses au toucher et que les câblages extérieurs connectés à ces dispositifs de connexion extérieure doivent être effectués par un opérateur formé ou en utilisant des cordons déjà préparés.

Cordon d'Alimentation

Évitez d'endommager le cordon d'alimentation. N'UTILISEZ PAS L'APPAREIL si le cordon d'alimentation est endommagé.

Service

Consultez un technicien qualifié pour l'entretien de votre appareil.

LS700P Parts List 8/31/2005

YS #	Description	Qty.	YS #	Description	Qty.	YS #	Description	Qty.
6405	RED 3MM LED 1V7 5MA BRT	2	3501	B52200F006 COMP WASH #4 SMALL	2	8823	6-32 X 1 PAN PH TAPTITE JS500	8
6410	GRN 3MM LED 1V7 5MA CLEAR BRT	1	3556	XSISTOR HOLD SPRING-BAR (PLATED)	4	8998	6-32 X 1 FLAT PH MS ZINC CLEAR	4
6419	BRIDGE 35A 400V WIRE LEAD G13504	2	3800	BELLY BUTTON #B1 CORDS CANADA	8	8803	8-32 X 3/8 PAN PH TAPTITE JS500	4
6425	BAV21 200V 0A25 DIODE T&R	8	3862	SIL PAD 400 1.5X6.75	2	8815	8-32 X 3/4 PAN PH TAPTITE JS500	12
6825	1N4148 75V 0A45 DIODE T&R	28	9897	CABINET COVER, BLACK, 54" WIDE	20.069	8749	10-32 X 1/2 QDX PH TAPTITE JS500	2
6438	1N4007 400V 1A0 DIODE T&R	16	3803	NYLON SECUR-A-TACH MINI PLASTIC TIE	1	8756	#10 X 3/4 PAN PH TYPE A BLACK OXIDE	40
6479	MUR415 150V 4A0 DIODE FASREC	12	3810	4" NYLON CABLE TIE	13	8727	#10 X 1" PAN PH TYPE A JS500 BLACK	24
5121	MZ4615RL 2V0 W25 ZENER 5% T&R	2	8661	BUTTON KNOB FLAT GREY	2	8786	10-32 X 1 1/4 PAN QD MS JS500 BLACK	8
6440	1N750ARL 4V7 0W5 ZENER 5% T&R	4	8693	S ROTARY KNOB GREY	2	8777	#14 X 1 FLAT PH TYPE A JS500 M6 HEAD	4
6436	1N753ARL 6V2 0W5 ZENER 5% T&R	1	3468	8' 3/16 SJT AC LINE CORD STRIP 17"	1	8928	#14X11/4 ALLEN FLHD WOOD SCRW JS500	6
6461	1N5240BRL 10V0 0W5 ZENER 5% T&R	6	3821	HEYCO #1200 STRAIN RELIEF	1	8794	5/16-18 X 3 1/2 GRD5 HEX BOLT JS500	1
6450	1N5242B 12V0 0W5 ZENER 5% T&R	2	8259D	"Y" LOGO ELITE SERIES LARGE DOMED	1	3741	.5 SPACER ID-.171 OD-.25 #912-500	6
6465	1N5250B 20V0 0W5 ZENER 5% T&R	1	3521	SIDE ENTRY PCB CONN .156 8POS	1	8657	6-32 X 3/8" HEX SPACER ALUMINUM	4
6856	NJM7815FA TO220 P 15V0 REG IS V1	1	3538	24 PIN BREAKAWAY LOCK .156	0.708	7269	10" 4R 350WPGM SPEAKER CAST FRAME	2
6857	NJM7915FA TO220 N 15V0 REG IS V2	1	3607	SIDE ENTRY PCB CONN. 9 POS.	1	8818	3/4 OD X 3/8 ID X .080 THICK WASHER	1
5101	BC550C TO92 NPN TRAN T&R TB	10	3674	9 CIR CABLE HOLDER .098	1	3511	#6 FLAT WASHER NYLON	2
5121	BC560C TO92 PNP TRANSISTOR T&R TB	5	8701	4-40 KEPS NUT ZINC	2	8485	#6 SPLIT WASHER ZINC	2
5109	MPSA43 TO92 NPN TRAN TA	10	8800	6-32 KEPS NUT ZINC	14	8820	#8 FLAT WASHER JS500	4
5114	MPSA92 TO92 PNP TRAN T&R TA	14	8797	5/16-18 KEPS NUT JS500	1	8473	#10 BLACK CUPWASHER SWF-10BK	1
5119	2N5638 TO92 NCH JFET T&R TC	4	4597	22AWG STRAN TC WIR JMP	9	3436	DPDT PUSH SW PCMT H BREAK B4 MAKE	2
6928	IRFP250 TO247 NCH MFET TM	6	4599	22AWG SOLID SC WIR T&R JMP	31	3585	DPDT ROKR SW QUIK 250" AC/PWR IEC65	1
6991	MJL21193 TO3P PNP TRAN TK	2	5299	24AWG SOLID SC WIR RAD JMP	7	3399	THERMO/BRKR-N/CLOSED OPEN@96C	1
6878	TL071CP IC FET OP AMP	1	4745	5.0W 0R1 5% BLK RES	6	8468	VELCRO STRAP 3/4"X22CM (VELSTRAP)	1
6882	TL072CP IC FET DUAL OP AMP	7	4688	1/2W 2R2 5% T&R RES	4	CH1287	PPW/EPW 120VAC 60HZ TRD	1
6745	LM13600N IC XCONDUCTANCE AMP	1	4748	2.0W 3R9 5% T&R	4			
5190	MBS4992 TO92 8V5 TRNSISTR DIAC T&R	2	4675	1/2W 10R 5% T&R RES	2			
6470	MAC15A6FP TO220 15A TRIAC 400V	2	2013	1/8W 22R1 1%FLAME PROOF T&R RES	2			
6472	4K7 3% 0W0 THERMISTOR	2	4816	1/4W 33R 5% T&R RES	1			
6473	68K 3% 0W0 THERMISTOR	4	2019	1/8W 100R0 1%FLAME PROOF T&R RES	2			
6482	115R 20% 0W0 PTC THERMISTOR	2	4921	1/4W 100R 5% .2"U T&R RES	6			
5405	.27P 200V 5%CAP T&R RAD CER.2"NPO	2	4909	1/4W 200R 5% T&R RES	2			
5199	100P 100V 2%CAP T&R RAD CER.2"NPO	4	4932	1/4W 200R 5% .2"U T&R RES	8			
5197	220P 100V 2%CAP T&R RAD CER.2"NPO	2	4857	1/4W 220R 5% T&R RES	2			
5201	470P 100V 5%CAP T&R RAD CER.2"NPO	10	2024	1/8W 249R 2%FLAME PROOF T&R RES	4			
5816	680P 100V 5%CAP T&R RAD CER.2"NPO	2	2025	1/8W 274R 1%FLAME PROOF T&R RES	4			
5275	.3N3 100V 5%CAP T&R RAD .2"FLM	6	4933	1/4W 470R 5% .2"U T&R RES	2			
5209	.4N7 250V 5%CAP T&R RAD .2"FLM	2	2028	1/8W 475R 1%FLAME PROOF T&R RES	4			
6451	.4N7 250V 20%CAP BLK 'Y' 10MM AC	1	2030	1/8W 681R 1%FLAME PROOF T&R RES	2			
5204	.10N 100V 10%CAP T&R RAD .2"FLM	1	4923	1/4W 680R 5% .2"U T&R RES	3			
5840	.22N 400V 10%CAP BLK RAD POLY FLM	1	4758	1/4W 953R 1% T&R RES	8			
6435	.22N 275V 20%CAP BLK 'X2' 15MM AC	1	4823	1/4W 1K 5% T&R RES	3			
5222	.33N 100V 10%CAP T&R RAD .2"FLM	1	4981	1/4W 1K 5%MINI T&R RES	1			
5224	.47N 100V 10%CAP T&R RAD .2"FLM	8	4825	1/4W 1K8 5% T&R RES	1			
5228	100N 100V 5%CAP T&R RAD .2"FLM	21	4936	1/4W 2K7 5% .2"U T&R RES	10			
5229	150N 63V 10%CAP T&R RAD .2"FLM	2	4764	1/4W 2K740 0.1% *** T&R RES	2			
5231	220N 63V 10%CAP T&R RAD .2"FLM	7	4826	1/4W 3K3 5% T&R RES	1			
5318	220N 50V 10%CAP T&R BEAD X7R	1	4943	1/4W 4K7 5% .2"U T&R RES	4			
5259	.4U7 63V 20%CAP T&R RAD .2"EL	2	4982	1/4W 4K7 5%MINI T&R RES	3			
5281	.10U 16V 20%CAP T&R RAD .2"NP	4	4939	1/4W 5K1 5% .2"U T&R RES	2			
5945	.10U 63V 20%CAP T&R RAD .2"EL	2	4685	1.0W 5K6 5% T&R RES	2			
5260	.22U 50V 20%CAP T&R RAD .2"EL	6	4862	1/4W 5K6 5% T&R RES	8			
5961	.33U 16V 20%CAP T&R RAD .2"NP	6	4829	1/4W 10K 5% T&R RES	6			
5265	.68U 25V 20%CAP T&R RAD .2"EL	4	4940	1/4W 10K 5% .2"U T&R RES	8			
5267	100U 25V 20%CAP T&R RAD .2"EL	3	4983	1/4W 10K 5%MINI T&R RES	9			
5914	100U 63V 20%CAP BLK 10X13MM EL	2	4630	1/2W 15K 5% T&R RES	3			
5621	470U 63V 20%CAP BLK 12X25MM EL	4	4885	1/4W 20K 5% T&R RES	4			
5859	4700U 50V 20%CAP BLK 25X36MM ELS	2	4832	1/4W 22K 5% T&R RES	2			
5890	5600U 100V 20%CAP RAD 35X50MM ELS	4	4941	1/4W 30K 5% .2"U T&R RES	8			
4403	.10K 5B LIN 16MM P14	1	4917	1/4W 31K6 1% T&R RES	6			
4389	.20K 1B LIN 16MM E432B STEREO P24	1	4840	1/4W 33K 5% T&R RES	5			
713	25 X 20 X 50 2 MIL PLASTIC BAG	1	6122	1/4W 33K 5%MINI T&R RES	5			
3819	.5UH COIL 18AWG R000 AIR CORE	2	4794	1/4W 37K90 0.1% *** T&R RES	2			
8483	ADAPTOR,SPEAKER STAND,METAL,BLACK	1	4878	1/4W 43K 5% T&R RES	2			
8547	PLASTIC FOOT BLACK, POLYETHYLENE	4	4834	1/4W 47K 5% T&R RES	2			
8567	CORNER, 2 LEGS/1 LIP BLACK OXIDE	2	6119	1/4W 47K 5%MINI T&R RES	2			
8569	CORNER, 2 LEGS NO LIP BLACK OXIDE	6	4835	1/4W 56K 5% T&R RES	2			
3489	CLIP 250X032 18-22AWG DISCO/INSL	7	4836	1/4W 68K 5% T&R RES	1			
3490	CLIP 250X032 14-16AWG DISCO/INSL	1	4763	1/4W 82K50 0.1% *** T&R RES	2			
3491	CLIP 205/187X020 18-22AWG DISCO/INS	4	4772	1/4W 82K5 1% T&R RES	4			
3601	RING TERMINAL 16AWG WIRE & #8 SCREW	2	4838	1/4W 100K 5% T&R RES	4			
3682	250 MALE PCB TAB REEL	19	6120	1/4W 100K 5%MINI T&R RES	1			
3795	#8 GROUND LUG ZIERICK 505-169	2	4839	1/4W 150K 5% T&R RES	2			
3498	1/4" JCK PCB MT HORZ	4	4841	1/4W 220K 5% T&R RES	6			
3451	EYELET SMALL 0.089 OD PLATED	57	4844	1/4W 1M 5% T&R RES	4			
3412	LOWPROFILE FUSEHOLDER FOR .25X1.25	1	4888	1/4W 4M7 5% T&R RES	1			
3414	INTERNATIONAL PC MOUNT FUSEHOLDER	8	8742	4-40 X 3/8 PAN PH TAPTITE JS500	16			
2427	5.0 AMP SLO-BLO .25X1.25 FUSE	1	8861	4-40 X 3/8 PAN PH MS JS500	2			
2438	12.0 AMP SLO-BLO .25X1.25 FUSE	4	8799	#6 X 1/4 PAN PH TYPE B JS500	1			
8565	BAR HANDLE ALL METAL	2	8801	6-32 X 3/8 PAN PH TAPTITE JS500	2			
8604	10-32 T NUT	8	8806	6-32 X 1/2 PAN PH TAPTITE JS500	2			

U:\M508AV16.PRN

A

FET_CNTL
CONNECTED TO M509 MX1

MC2
9
8
7
6
5
4
3
2
1
NEG_IN_R
POS_IN_R
CLIP_R
GND
GND
CLIP_L
POS_IN_L
NEG_IN_L

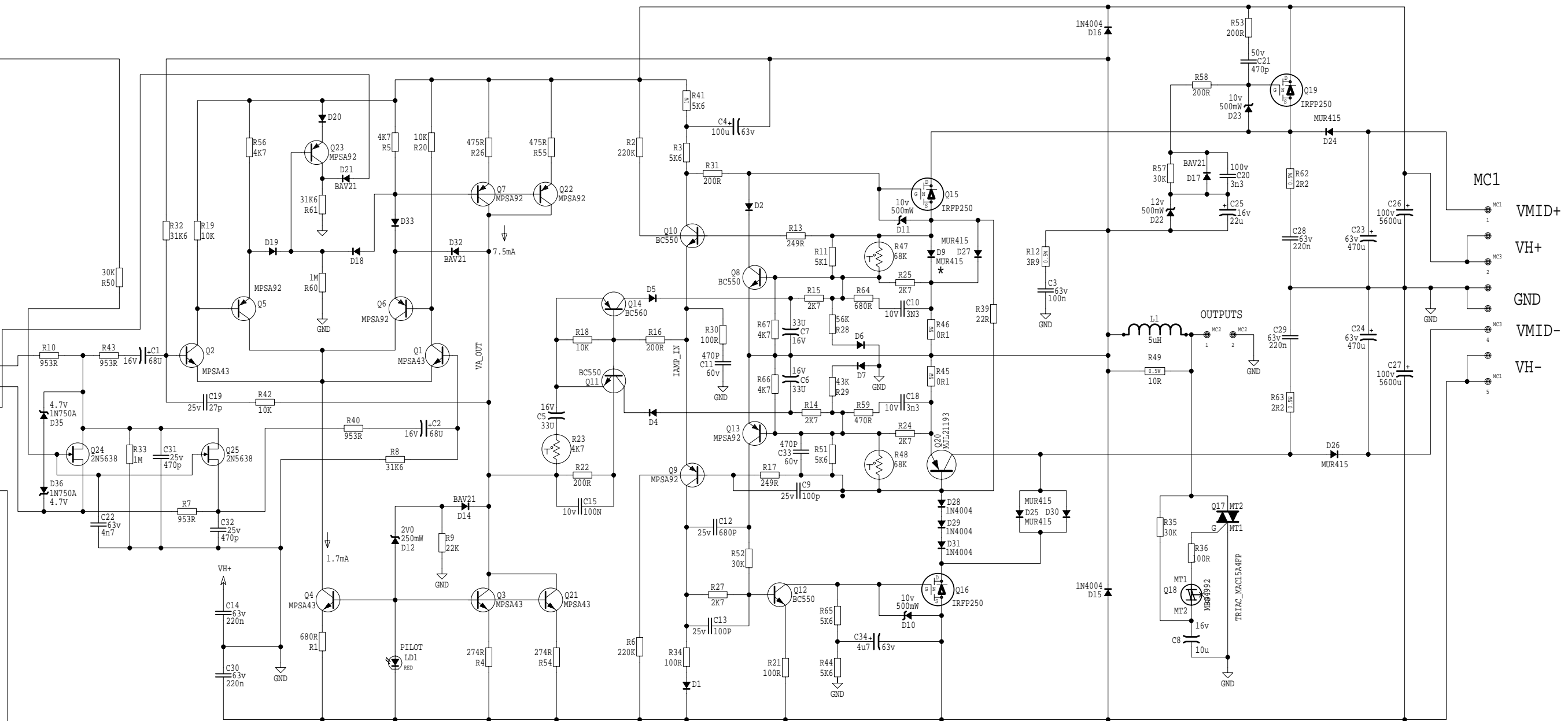

SERVICE WARNING: POTENTIALS GREATER THAN 130VDC PRESENT.

USE EXTREME CAUTION.

CLIP_L
POS_IN_L
NEG_IN_L

CONNECTIONS TO
THE LEFT CHAN
AMPLIFIER

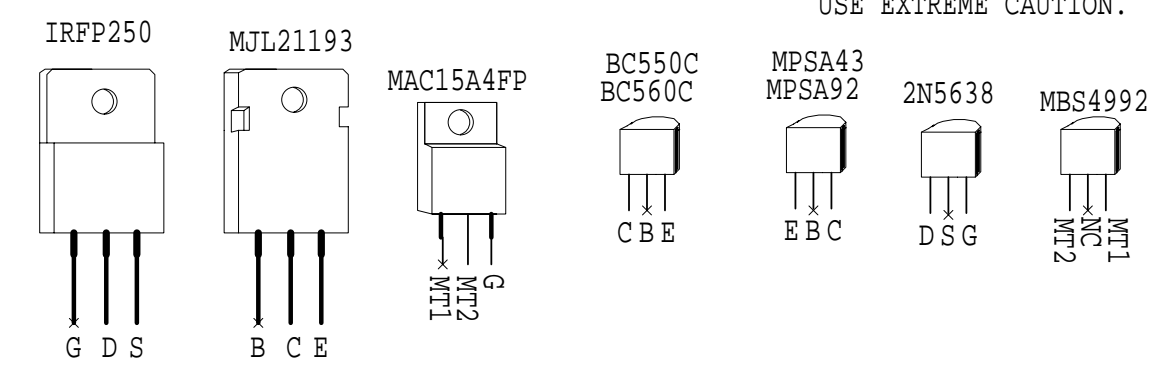

M508A.SCH_DATABASE_HISTORY			
MODEL(S) :- LS700P-PS218P			
#	DATE	VER#	DESCRIPTION OF CHANGE
1	AUG/26/04	1.60	PC#6722_ADD_R66,R67_E->B,Q13,Q8
2	D	V	N
3	D	V	N
4	D	V	N
5	D	V	N
6	D	V	N
7	D	V	N
8	D	V	N
9	D	V	N
10	D	V	N

M508A /LS700P/PS218/PS210P PRODUCTION NOTES

AUTO-INSERTION

- Q1L/Q1R, Q2L/Q2R
THE ABOVE TRANSISTORS MUST BE FROM THE SAME BATCH (MANUFACTURERS LOT #)

BOARD ASSEMBLY

- ADD RTV TO THE FOLLOWING COMPONENTS C34L/R, C5L/R, C1L/R, C2L/R, L1L/R R45L/R, R46L/R, C6L/R, C8L/R, C25L/R ADD RTV BETWEEN C23L/R , C24L/R AND C7L/R,C26L/R.
LD1L/R ARE BENT OVER FLAT TO PCB AND RTV'D IN PLACE
C26 AND C27 ARE BROKEN AWAY AFTER WAVE SOLDER AND SOLDERED MANUALLY TO THEIR CORRECT POSITION. THESE CAPS ARE RTV'D AND HELD IN POSITION WITH NYLON CABLE TIES.
- ADD RTV UNDER THE MOLEX RIBBON CABLE BEFORE IT IS PUT INTO THE STRAIN RELIEF.
- ADD TOOTH PICKS TO EYELETS BEFORE WAVE SOLDER.
- USE #8799 SCREW TO MOUNT Q17L/R.
- BEND THERMISTORS R23L/R OVER FLAT TO PCB.
- Q9R Q9L TO BE HAND INSERTED
- R66R/L R67R/L TO BE TACKED ON IN BOARD ASSEMBLY

2 oz COPPER

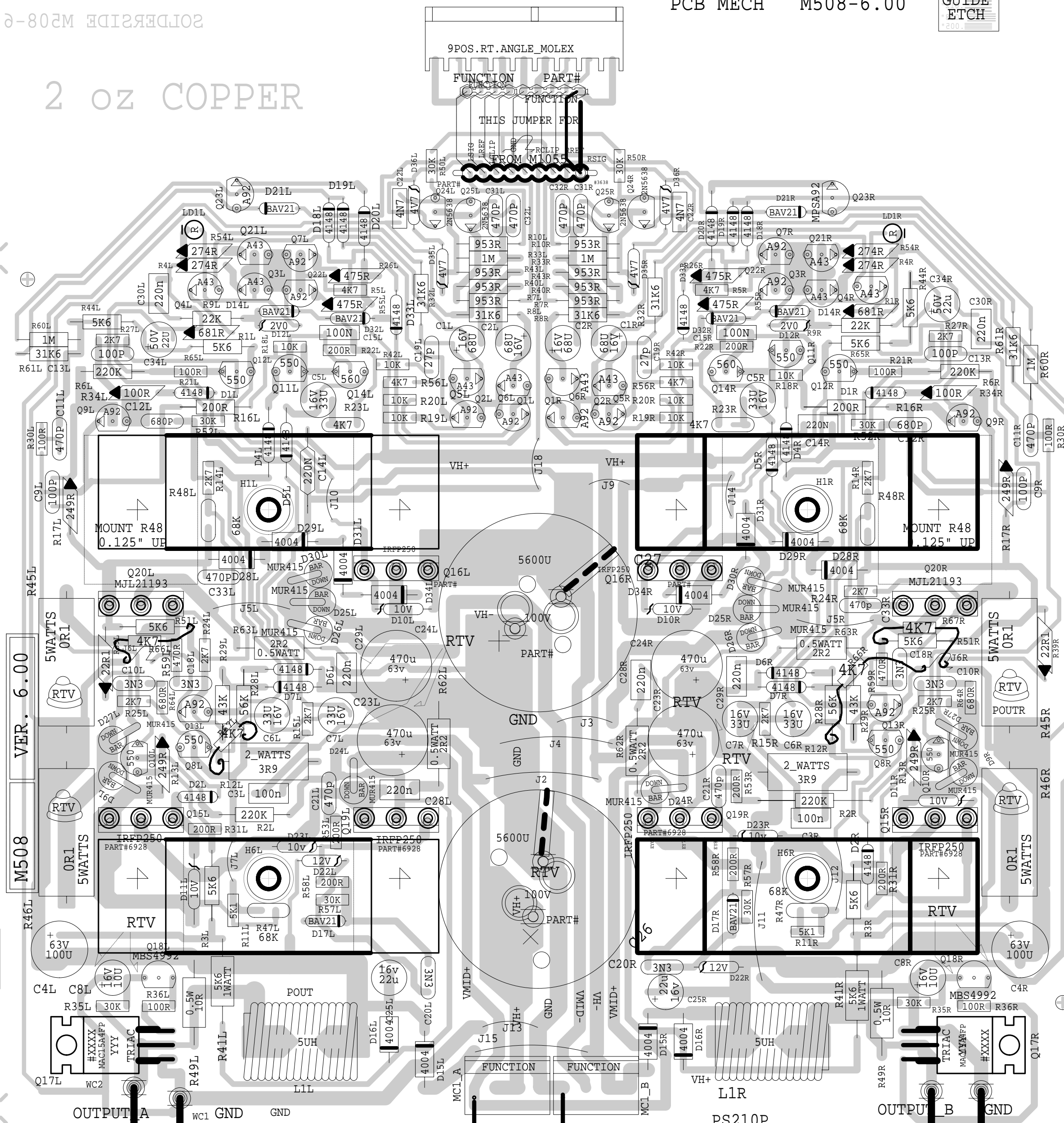

M508/A/C.PCB_DATABASE_HISTORY			
MODEL(S):- LS700P PS218 PS210PX			
#	DATE	VER#	DESCRIPTION OF CHANGE
1	FEB/24/95	3.40	SOME TRACES ALTERED.PADS FOR MOLEX CHANGED FROM S100 TO R120.
2	.	.	ROUTING BY FILTER CAPS CHANGED.
3	AUG/27/97	4.00	PC#XXXX FILTER CAPS CHANGED
4	.	.	PC#4409_Q11R_MOVED
5	SEP/05/97	.	PC#XXXX_Q1L/R_Q2L/R_MOVED
6	MAR/25/98	5.00	J10_RADIAL->AXIAL
7	SEP/08/03	5.10	PC#6621_ALL MPSA93->MPSA92
8	AUG/26/04	5.20	PC#6722 TACK-ON 4K7 E->B
9	.	.	Q8R/L,Q13L/R,R66,R67-L/R
10	JUN/16/05	6.00	PC#6878 REDO SOLDERMASK
11			N
12			N
13			N
14			N
15			N
16			N
17			N
18			N
19			N
20			N

PS210P
27" RED #3491 CLIP
27" BLACK #3491 CLIP

PS218P
250 CLIP
250 CLIP
12" BLACK
9" GREEN
9" GREEN

LS700P
250 CLIP
250 CLIP
12" RED
30" RED
9 1/2" RED
NO CLIP
#3491 CLIP
NO CLIP

250.8X"28.71"=5512 XMA1B
BLANK SIZE=17.35"X8.625"

M508 VER. 6.00

GUIDE ETCH

SHEAR

M200-8-00

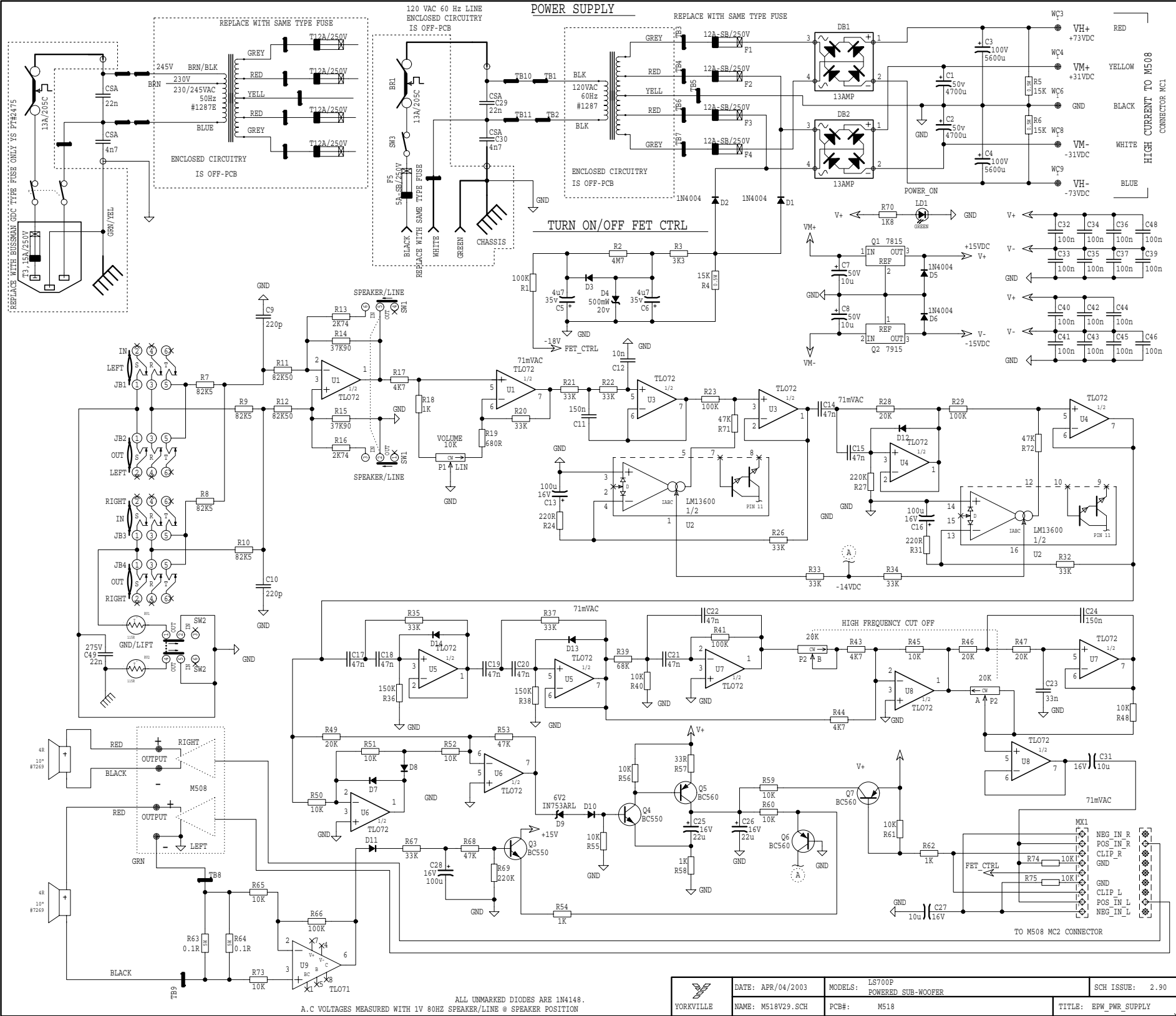

ALL UNMARKED DIODES ARE 1N4148.
A.C VOLTAGES MEASURED WITH 1V 80HZ SPEAKER/LINE @ SPEAKER POSITION

YORKVILLE	DATE: APR/04/2003	MODELS: LS700P POWERED SUB-WOOFER	SCH ISSUE: 2.90
	NAME: M518V29.SCH	PCB#: M518	TITLE: BFW_PWR_SUPPLY

M518.SCH DATABASE HISTORY

#	DATE	VER#	DESCRIPTION OF CHANGE
1	AUG/24/95		
2	SEP/12/95		
3			PC#4871 R45 4K7 TO 10K R11,R12 9K760 TO 82K50
4	APR/03/96	2.10	PC#4886 REPLACE R25,R30 WITH JUMPER ADD 47K (R71,R72 IN SERIES WITH PIN 3 OF U9. R65 1K TO 10K
5	JUN/27/97	2.20	REVISIONS & PARTIFICATIONS
6	AUG/06/98	2.30	PC#5785 PRIMARY FUSE_CE T5A->T2_5A NA 8A-SB->5A-SB
7			
8	SEP/15/98	2.40	REPLACE FUSE SYMBOL
9	JAN/25/99	2.50	CE XFMR WIRE COLOURS UPDATED
10	JUL/14/99	2.60	R7U 1/2W->1/W TO AGREE WITH LAYOUT
11		2.70	
12		2.80	

LS700P

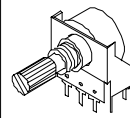

STYLE "P24"

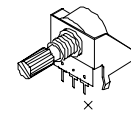

STYLE "P14"

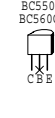
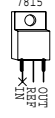
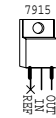



00.L1-8L2M EDI29EQD102
 ASSEMBLY M518-11.00
 PCB MECH M518-11.00

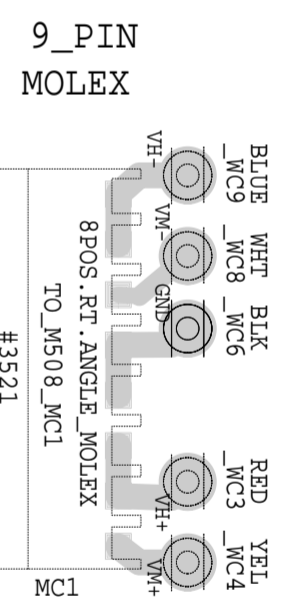
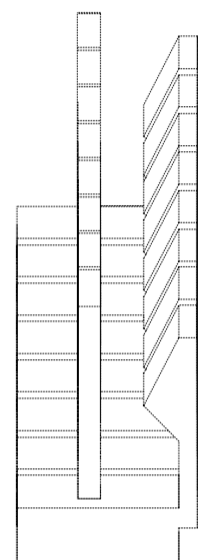
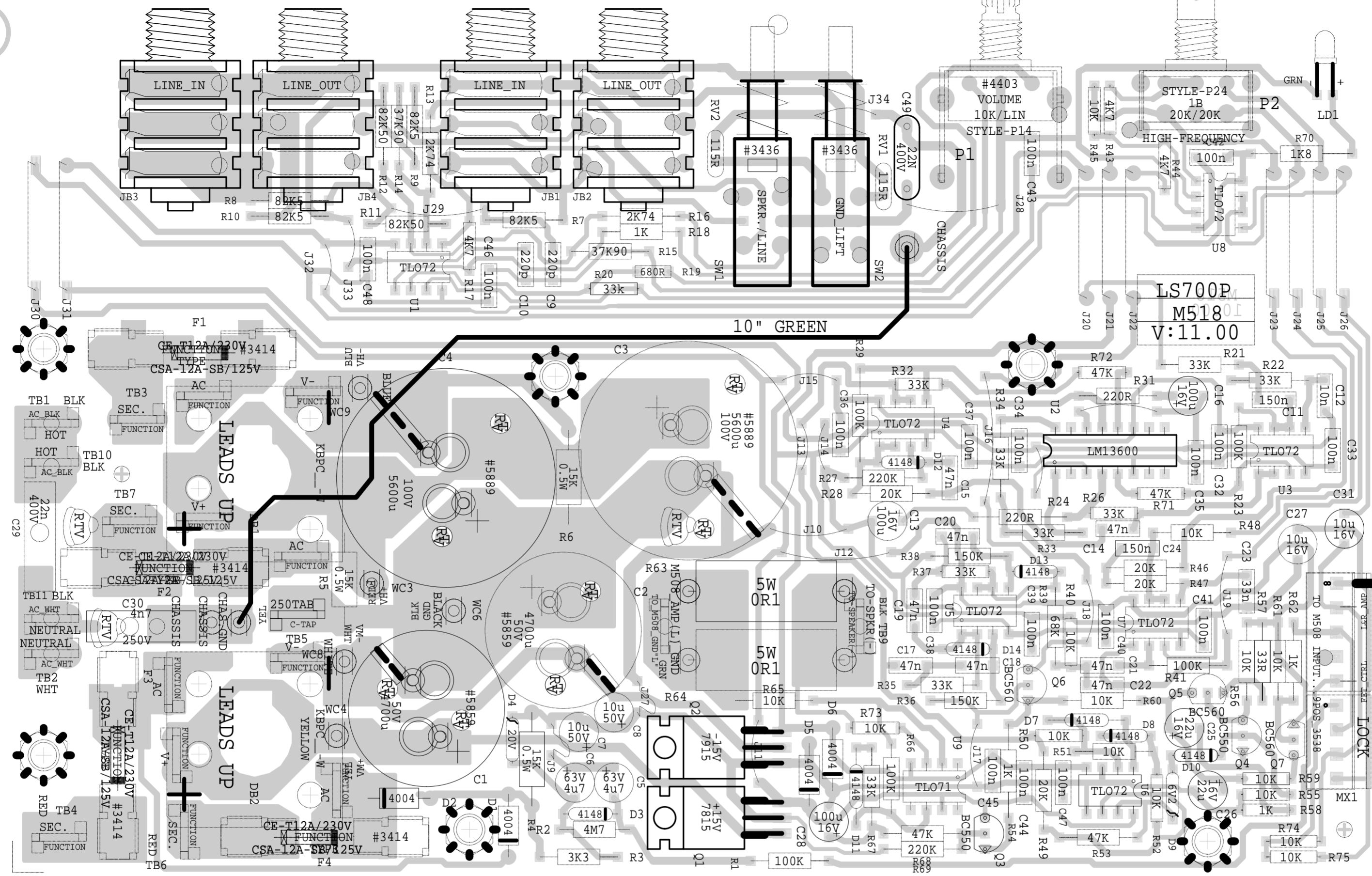

"008.01X" 02S, SL=EN12, MIAL1B
 BLANK SIZE=12.250" X 10.800"

M518.PCB_DATABASE_HISTORY

MODEL(S):- LS700P

#	DATE	VER#	DESCRIPTION OF CHANGE
1	AUG/21/95	1.00	DESIGN BY TOM WOOD
2	AUG/24/95	1.10	PC#4871 R45 4K7-->10K_R11,R12_9K760-->82K50_0.1%
3	.	.	PC#4877 MOVE RTV HOLES FOR C1
4	SEP/01/95	1.20	PC#4885/4886 REPLACE R25,30 WITH JUMPERS ADD 10K IN SERIES WITH
5	SEP/12/95	2.00	PIN 3 U9 ADD 47K IN SERIES WITH PIN 5,12 U2 R65 1K->10K_R66 10K->100K
6	.	.	C27 MOVED FOR CLEARANCE AT MOLEX
7	.	.	
8	.	.	
9	SEP/25/95	2.10	PC#5079 R18 2K74 -> 1K
10	APR/3/96	2.11	PC#5303 C7 MOVED.ROUTING AT JACKS CHGD
11	MAY/20/97	3.00	PC#6130 MOVE R3 AWAY FROM R2
12	OCT/06/99	4.00	PC#6109 REDO GND LIFT SW. ADD C49
13	.	.	ADD EYELET. CHANGE PADS FOR RAD JUMPR
14	DEC/02/99	5.00	NEW PADS FOR TABS AND FUSEHOLDERS
15	APR/18/02	6.00	PC#6413 FIX TRACES AT U5
16	JUL/16/02	7.00	ADD ROUTING NO OTHER CHANGES
17	OCT/23/02	7.10	PC#6573 TABS FOR BRIDGE
18	NOV/14/02	8.00	PC6596 ADD R74, R75
19	APR/04/03	9.00	MOVE FUSEHOLDER AWAY FROM TRACE
20	SEP/02/03	10.00	
21	JUN/16/05	11.00	PC#6905 ADD ROUTGAUGE REDO MASK



M518.PCB_POT_LIST

MODEL(S):- EPW/LS700P

REF	FUNCTION	PART#	KNOB	AS_OF
P1	VOLUME	#4403	#8693	DEC/99
P2	HIGH_FREQ	#4389	#8693	DEC/99
R	F	P	K	N
R	F	P	K	N
R	F	P	K	N
R	F	P	K	N

PRODUCTION NOTES

1 NOTE ORIENTATION OF LOCK ON THE MOLEX FOR MX1

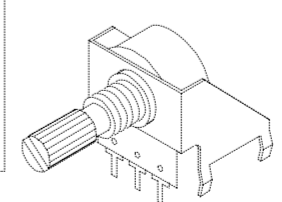

STYLE "P14"

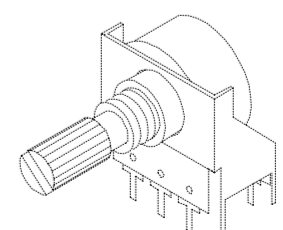

STYLE "P24"

LS700P AC WIRES EXPORT VERSION
 NOV 2005

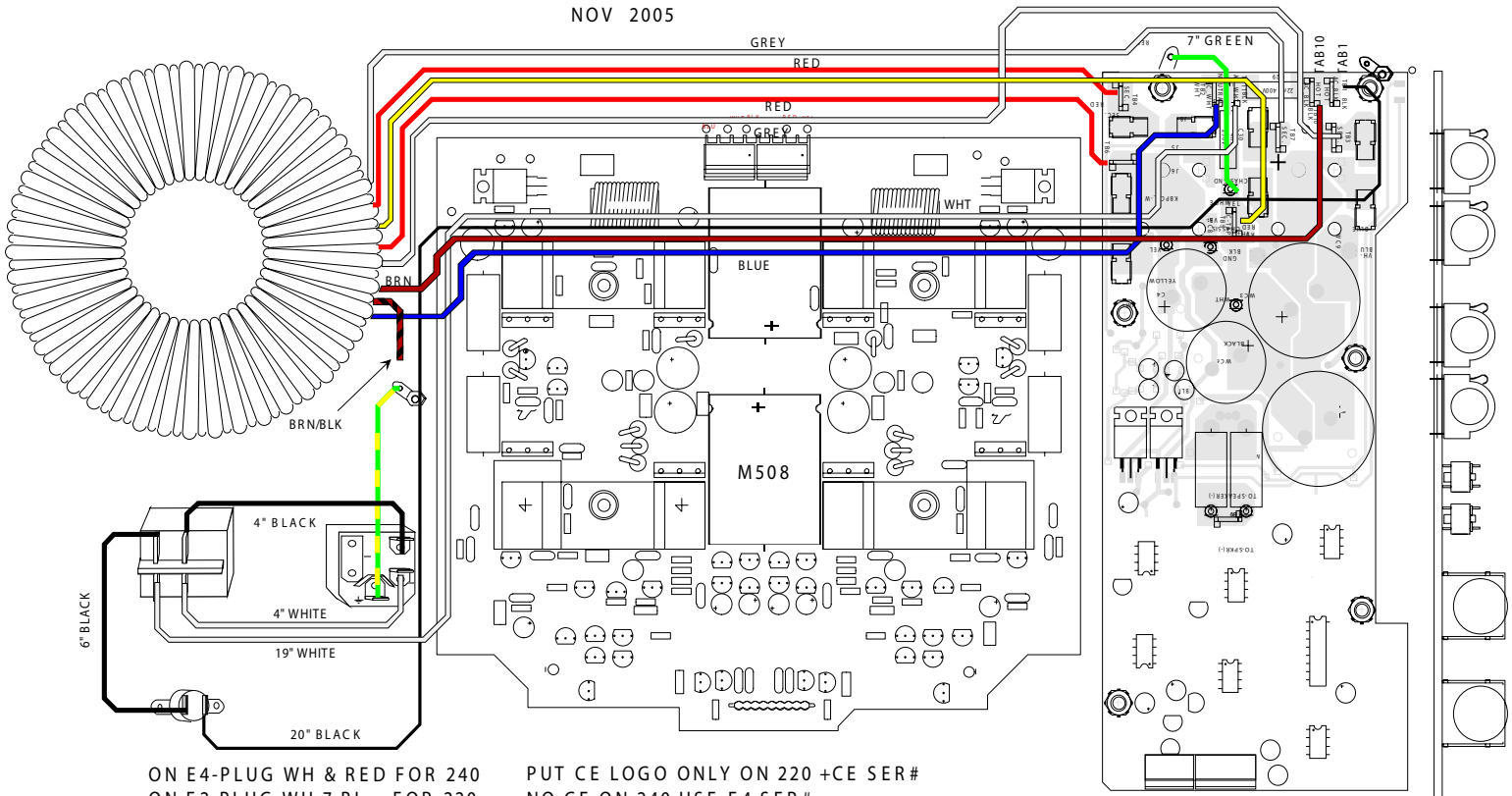

ON E4-PLUG WH & RED FOR 240
 ON E2-PLUG WH 7 BL FOR 220
 PUT 3487 CLIP ON UNUSED PIN

PUT CE LOGO ONLY ON 220 +CE SER#
 NO CE ON 240 USE E4 SER#
 SHOWN WIRED FOR 230V

LS700P AC WIRES EXPORT VERSION
 APR 22, 2003

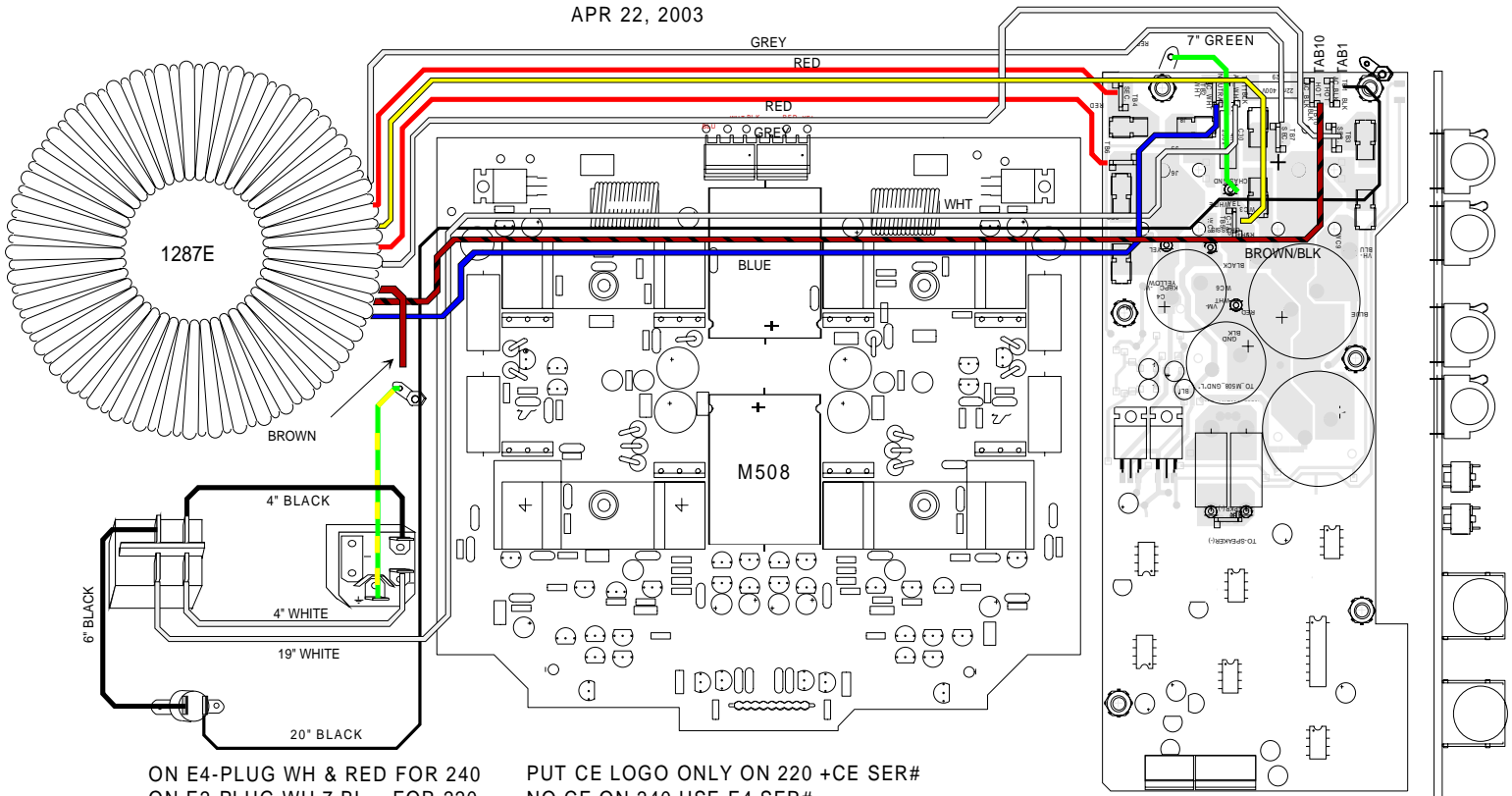

ON E4-PLUG WH & RED FOR 240
 ON E2-PLUG WH 7 BL FOR 220
 PUT 3487 CLIP ON UNUSED PIN

PUT CE LOGO ONLY ON 220 +CE SER#
 NO CE ON 240 USE E4 SER#
 SHOWN WIRED FOR 245V